

MIMOSA / bracciolo 20 cm

ELEMENTI TRASFORMABILI A LETTO

Rete cinghie, materasso cm 14 trapuntato
Schienali e sedili in in poliuretano espanso

Per le versioni dei divani letto con materasso da 18 cm NON è prevista alcuna componibilità, in quanto l'altezza dello schienale è di + 5 cm rispetto allo standard.

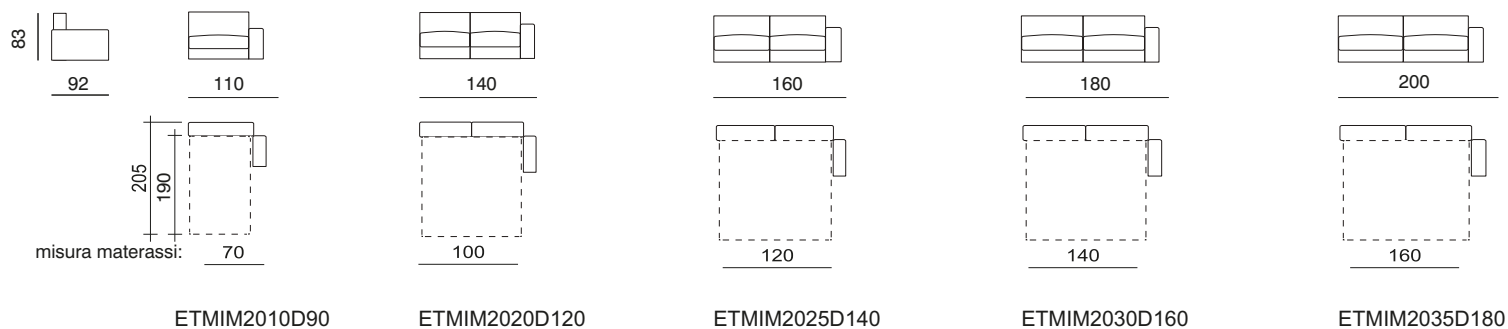
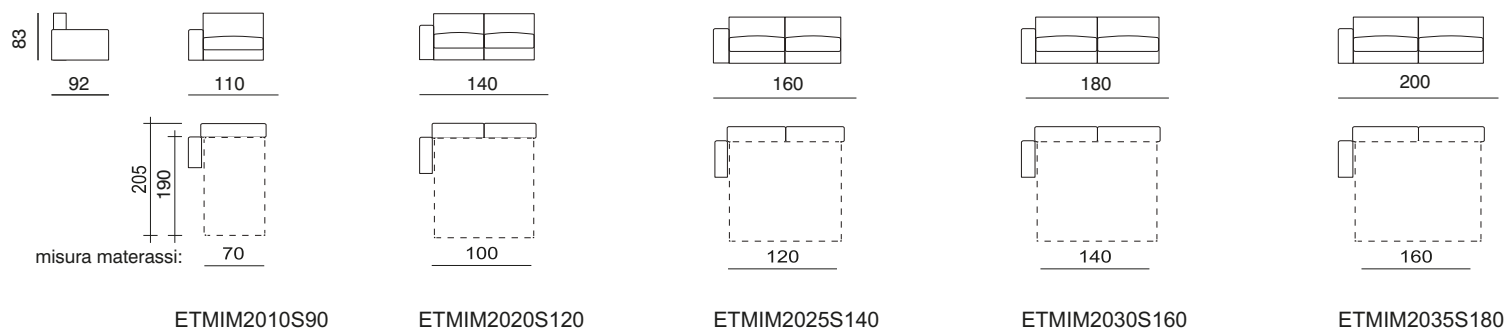
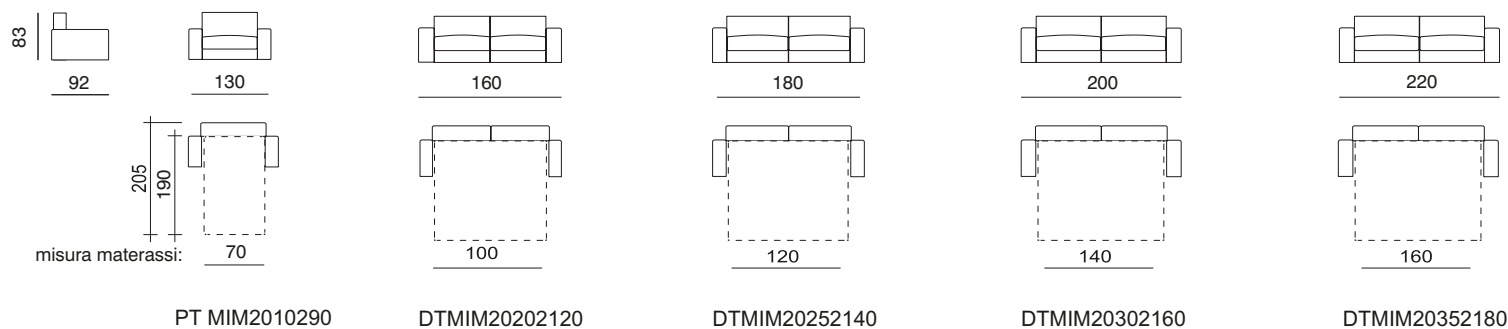

MIMOSA / bracciolo 20 cm

ELEMENTI FISSI

83



92



110



130



160



180



200



220

PFMIM2010270

PFMIM2015290

DF MIM20202120

DF MIM20252140

DF MIM20302160

DF MIM20352180



90



110

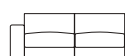

140

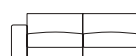

160

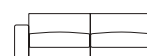

180

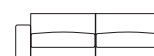

200

EFMIM2010S70

EFMIM2015S90

EFMIM2020S120

EFMIM2025S140

EFMIM2030S160

EFMIM2035S180



90



110

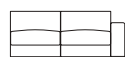

140



160



180

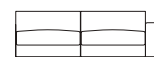

200

EFMIM2010D70

EFMIM2015D90

EFMIM2020D120

EFMIM2025D140

EFMIM2030D160

EFMIM2035D180

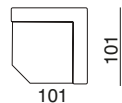

101

101

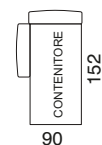

90

152

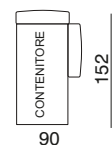

90

152

ANMIM20ANQ101101

PNMIM20PECS90152

PNMIM20PECD90152

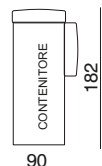

90

182

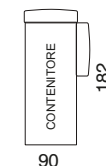

90

182

PNMIM20PECS90182

PNMIM20PECD90182